

# CCpilot V700

## Technical Manual



## 1. Introduction

*CCpilot V700* is a freely programmable display computer with 7" high brightness full-colour WVGA TFT with PCAP touch screen. The strong LED backlight in combination with the optically bonded PCAP, results in excellent sunlight readability.

The powerful i.MX8X ARM® based main CPU and Linux® operating system constitute an open platform that facilitates the implementation of premium user-machine interaction, reliable controls and integrated fleet management solutions. In addition, there is one co-processor responsible for hardware control and supervision.

This technical manual provides important information regarding the product's hardware and its basic usage. For software and operating system specifics, please see additional documentation.

## Revision history

| Rev | Date       | Author | Comments        |
|-----|------------|--------|-----------------|
| 1.0 | 2020-09-10 | FMG    | Release Version |

## Contents

|  |           |
|--|-----------|
| <b>1. Introduction.....</b>              | <b>2</b>  |
| <b>Revision history .....</b>            | <b>2</b>  |
| <b>2. Product models .....</b>           | <b>4</b>  |
| 2.2. Document conventions .....          | 4         |
| 2.3. Identification .....                | 4         |
| 2.4. Environmental resistance .....      | 5         |
| <b>3. Product overview.....</b>          | <b>5</b>  |
| 3.1. Front side view .....               | 5         |
| 3.2. Rear side view .....                | 5         |
| 3.3. Connector side view .....           | 6         |
| <b>4. Mounting and handling .....</b>    | <b>6</b>  |
| 4.1. Mounting .....                      | 6         |
| 4.2. Connecting to power supply .....    | 9         |
| 4.3. Cable installation .....            | 11        |
| 4.4. Special considerations .....        | 11        |
| 4.5. Handling and maintenance.....       | 12        |
| 4.6. Transportation.....                 | 13        |
| <b>5. Basic operation.....</b>           | <b>14</b> |
| 5.1. Turning ON .....                    | 14        |
| 5.2. Turning OFF and suspending .....    | 14        |
| 5.3. Light sensor .....                  | 15        |
| 5.4. Using the touch screen .....        | 16        |
| 5.5. Status notification .....           | 16        |
| 5.6. Error codes .....                   | 16        |
| <b>6. Interface overview .....</b>       | <b>18</b> |
| 6.1. Front panel.....                    | 18        |
| 6.2. Buzzer.....                         | 18        |
| 6.3. CAN .....                           | 18        |
| 6.4. Ethernet .....                      | 18        |
| 6.5. USB .....                           | 19        |
| 6.6. Bluetooth.....                      | 19        |
| <b>7. Connectors .....</b>               | <b>20</b> |
| 7.1. M12 connectors, general.....        | 20        |
| 7.2. Power and CAN M12 pinout .....      | 20        |
| 7.3. Ethernet M12 pinout .....           | 21        |
| 7.4. USB M12 connector pinout .....      | 21        |
| <b>8. Specifications .....</b>           | <b>22</b> |
| 8.1. Technical data .....                | 22        |
| 8.2. Environmental specifications.....   | 24        |
| 8.3. EMC specification.....              | 24        |
| 8.4. Weight and dimensions.....          | 25        |
| <b>Technical support .....</b>           | <b>26</b> |
| <b>Trademarks and terms of use .....</b> | <b>27</b> |

## 2. Product models

This documentation is applicable for all CCpilot V700 models. These models are:

- CCpilot V700 standard version of product. Part number C000152-04
- CCpilot V700 standard with Bluetooth module. Part number: C000152-01
- CCpilot V700 custom version. Part number C000152-02.

These models share the same level of performance, hardware architecture, TFT, enclosure and connectors. The PCB is the same for all versions but may be populated differently.



### 2.1.1. Customized models

The platform enables additional customization of hardware and software. Described herein are the features included in product models described above. Additional features in customized models will be documented separately.

Contact CrossControl for customization inquiries.

## 2.2. Document conventions

This document uses the following conventions:

| Description                        | Appearance   |
|------------------------------------|--|
| Important information              |  (exclamation symbol) |
| Differences between product models |  (observe' symbol)    |

Text formats used in this document are described in the table below:

| Format         | Use  |
|----------------|--|
| <i>Italics</i> | <i>Names, designations, and references</i> |
| <b>Bolded</b>  | <b>Important information</b>               |

## 2.3. Identification

Each device has identification labels with serial number, part number and revision which identifies your unique device. This information is required when communicating with CrossControl regarding Technical support and Service/Repair needs.

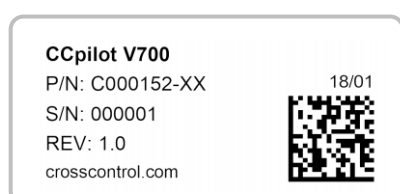

Figure 1: Identification labels

## 2.4. Environmental resistance

The CCpilot V700 product has been designed to manage tough environmental demands. Much effort has been put into designing and selecting system components to provide a reliable and robust device.

Thorough testing has been performed in order to ensure compliance to a broad range of applicable regulatory requirements and to meet user demands of a ruggedized product for machinery control.

A complete list of standards to which the product has been tested for compliance can be found in chapters 8.2 and 8.3.

## 3. Product overview

This chapter contains illustrations of the CCpilot V700 showing the location of external connectors, indicators etc. Connectors are described in more detail in chapter 7. Additional mechanical information can be found in chapter 8.4.

### 3.1. Front side view

At the front side of the device there is a 7" display with projected capacitive touch-sensor (PCAP). There is also a light sensor and an RGB status LED in the front. The light sensor enables automatic dimming of display and the RGB status LED shows operation modes or fault indications.

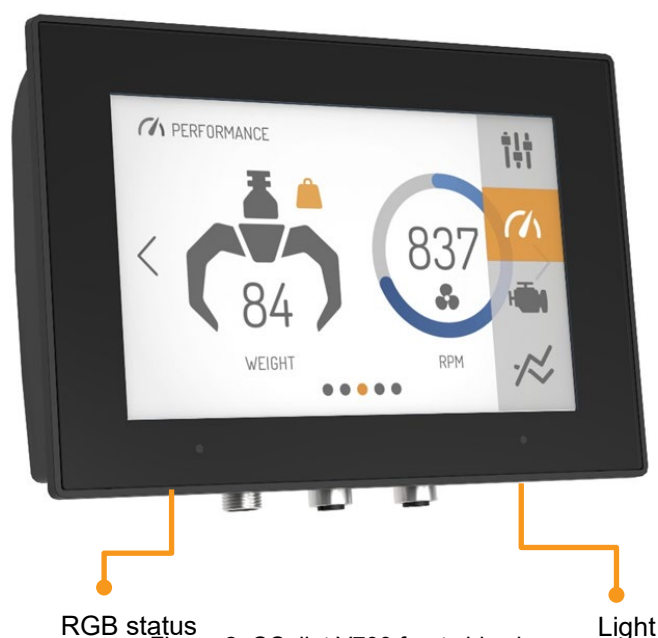

Figure 2: CCpilot V700 front side view

### 3.2. Rear side view

The rear side contains the mounting holes for either a fastener in accordance with 1.5" RAM<sup>®</sup> ball mount (RAM-202U) or custom bracket for panel mounting and a GORE-TEX<sup>®</sup> membrane for ventilation.



Figure 3: CCpilot V700 rear side view

### 3.3. Connector side view

At the side of the device there are external interface connectors, i.e. 3 x M12 for Power, CAN, Ethernet and USB.

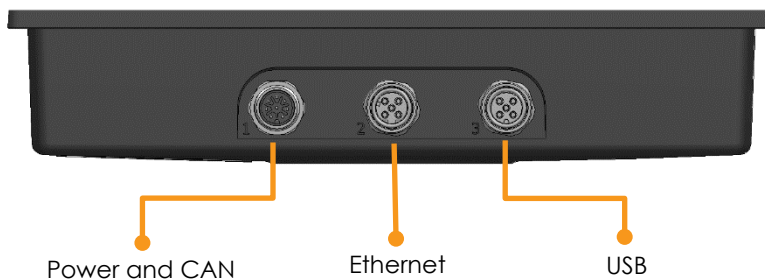

Figure 4: CCpilot V700 connector side

## 4. Mounting and handling

This chapter contains recommendations for installation, handling and maintenance of the product.

### 4.1. Mounting

CCpilot V700 supports two different mounting methods, a RAM mount or a panel mount. These two mounting methods are described separately below.

For both fastening methods, use the appropriate 3 pc. M5 x 0.8 button head screw of type MRT (Torx) The recommended torque for the screws is 1.5-2.0 Nm. Using fluid locker or locking washers (split ring, toothed lock, etc.) is required for proper mounting. Ensure that the M5 mounting screws are clean and dry before mounting.



Note that the depth of the threaded holes is 8 mm. Be careful not to use too long screws which may damage the device when tightened. It is also very important to use a fastening plate with holes that are not larger in diameter than 6 mm to avoid pulling out the threaded inserts from the unit.

#### 4.1.1. RAM mount

CCpilot V700 can be mounted using a RAM mount, i.e. RAM-202U, a round base 1.5" ball mount which allows adjustment of the display's position and angle. Screw length should be 12mm.



Figure 5: 3 hole ram mount

#### 4.1.2. Panel mount

Alternatively, the device can be mounted in a panel-cutout using a panel mounting bracket (article number C000152-48), Screw length should be 10mm.

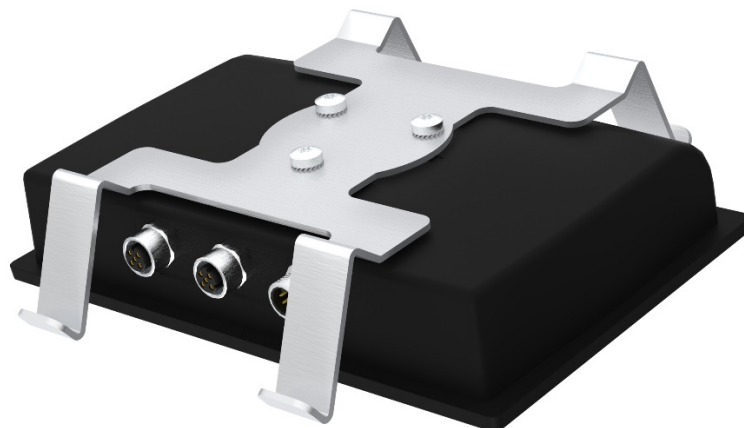

Figure 6: Mounting bracket

The mounting bracket is designed for a panel thickness of 1.5 - 3.0 mm. Panel cut out dimensions are shown in the figure below. A drawing in DXF-format for precision cutting of panels is available upon request. Screw length should be 10mm.







Ensure that CCpilot V700 is mounted to a smooth, flat surface. Fastening the unit to an uneven surface may stress the enclosure, damage the outer flange or possibly even flex the circuit board inside, leading to a premature failure.

## 4.2. Connecting to power supply

This chapter describes how the CCpilot V700 is preferably connected to the power supply of the equipment it is installed in. The principle is the same for vehicular and stationary installations.



Carefully read through the following sub-chapters. They are critical for designing and adapting the electrical system of the equipment in which the CCpilot V700 is installed. Connector pinouts are found in chapter 7.

### 4.2.1. Wire gauge

Wire gauge for the power supply should be dimensioned with respect to the total load current, the cable length required, and the worst-case voltage drop allowed, considering the minimum operational voltage of the device.

- Current consumption of the CCpilot V700 device is found in chapter 8.1.
- The wire gauge for the power supply is recommended to be at least 0.75 mm<sup>2</sup> /AWG 18 for “normal” loads.

### 4.2.2. External fuse



To prevent cable fire in case of short circuit, an external fuse must always be used when powering the device from a high current capable power source, for example a vehicle battery.

- The fuse shall be located as close to the battery/power source as practically possible. A recommendation is to place the fuse at a maximum distance of 15 cm (6 inches) from the (+) terminal of the source.
- Fuse rating shall be dimensioned with respect to wire gauge, maximum current consumption and the inrush current of the device. Refer to chapter 8.1 for fuse rating details.
- As a guideline, a slow acting fuse with 2-3 A current rating should be used.
- Remember to also apply fusing for the on/off control wiring, see chapter 4.2.4.

### 4.2.3. External key switch signal

The device's key switch signal should be connected to the positive supply line via the vehicle's ignition key switch.

- The wire gauge for the key switch signal shall be dimensioned to handle the total switch current and the fuse type and rating shall be selected to prevent cable fire in case of cabling short circuit.
- As a guideline, a slow acting fuse in the range of 100-5000 mA for the key switch signal should be sufficient for most practically usable wire gauge.

#### 4.2.4. Application example

Below is an application example schematic of the CCpilot V700 power supply connection.

If the system has a main switch for completely disconnecting the battery (S1 in schematic below), the device's power supply and key switch signal shall be connected after the main switch.



It is **not** recommended to disconnect the battery without shutting down the device first - since doing so will immediately switch off all internal voltages, regardless of ongoing operations. Any information which was not saved to flash memory will be lost when disconnecting the battery. However, no physical damage will be caused to the device by disconnecting the battery.

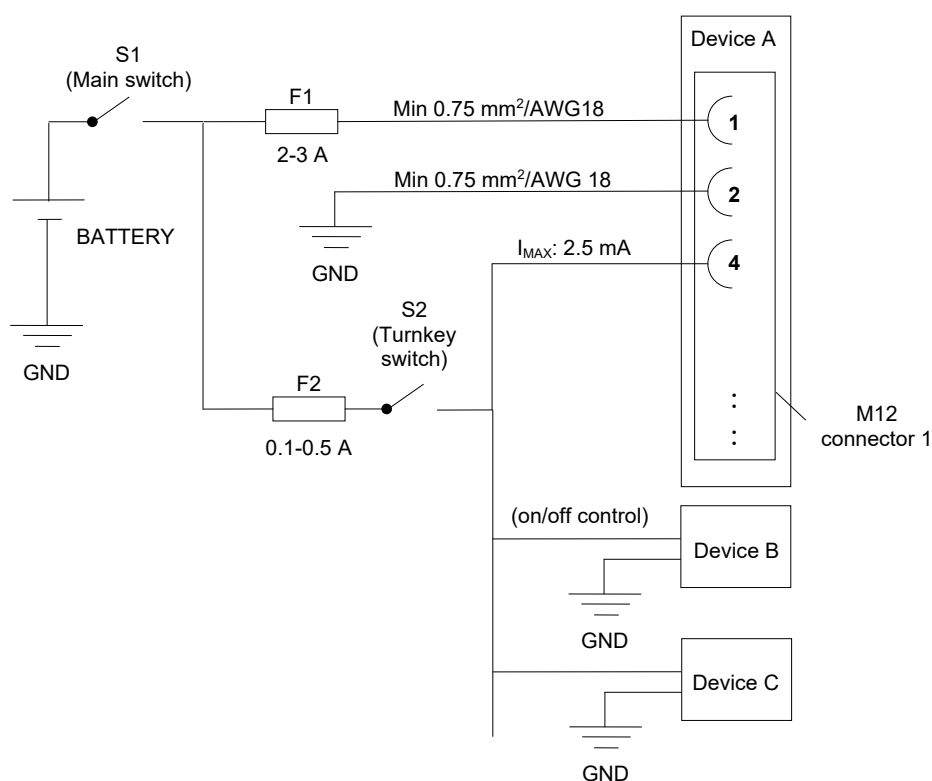

Figure 7: Schematic example for power supply installation of a CCpilot V700 device in a vehicle. The ignition switch (S2) can be shared by several devices (Device X, Y, ...)

By connecting the power supply according to the example above, the CCpilot V700 device will automatically start up when the key switch (S2) is closed and shut down when the switch is opened.



Note that the on/off behaviour of the CCpilot V700 described here is the default configuration. Its response to the on/off signal may be altered using the CCAux API, see chapter 5.1 for more details.



Be advised that the device consumes a small amount of power from the main supply also when shutdown (123  $\mu$ A at 12V, 0.38mA at 24V) or suspended (37mA at 12V, 22mA at 24V). Therefore, if the device has been attached for a long period of time without the vehicle motor

running, the battery may be drained, resulting in inability to start up the vehicle. A main switch for disconnecting the device's main supply is highly recommended in such situations.

### 4.3. Cable installation

Cables shall be installed in such a way that they do not run any risk of being damaged, pinched or worn.

- Avoid excessive bending and twisting of cables.
- Use strain-relief on cables near the device to minimize stress on cables and connectors.
- Properly snap the connectors to give reliable contact and sealing and to avoid unnecessary strain.
- Shielded cables are recommended and, in some cases, necessary to ensure reliable communication and appliance with agricultural EMC standards.

#### 4.3.1. Recommendations for cable shields



To achieve electromagnetic compliance and stable operation of the system, shielded cables are required for Ethernet and USB interfaces.

### 4.4. Special considerations



To ensure proper and reliable operation and to retain IP-classification of the device, below recommendations must be followed:

- The device should be placed in a way that prevents direct and continuous exposure to water or close proximity to hot-air vents.
- To enable sufficient cooling, the device must be installed in a way that allows ambient air to circulate around it. A clearance of at least 50 mm around the device is recommended.
- To maintain IP classification, all M12 connectors must have a mating external connector attached. Protective caps shall be used on all non-mated connectors. Please note that the protective caps mounted on the M12 connectors are for transportation protection only.
- The device has a ventilation membrane, refer to Figure 3 for the location. For proper ventilation of the device, dirt and water must be prevented from accumulating and covering the membrane. Be cautious not to insert objects which may puncture the membrane. Doing so will violate the IP-classification and void the warranty of the device.
- Install the device and any cables attached in a way that they are not subject to excess vibrations or other potentially harmful stress.
- Loose fasteners are a common cause for excessive vibration. Fasteners may come loose due to improper mounting techniques such as omitting thread lockers (fluid locker or locking washers) or by over/under-tightening. Proper tightening requires dry, clean fasteners and a torque wrench.
- If the device is exposed to chemicals, water, dirt or other pollutants, it is recommended to have it cleaned off as soon as possible. See chapter 4.5.1 for cleaning instructions.

## 4.5. Handling and maintenance

Handle the device with care and pay attention to the following handling instructions:



- Disconnect all cables to the device during welding or when performing other service to the machine imposing a risk of damaging electronic devices.
- Service and repair to the device shall only be made by authorized personnel. If the device is opened by unauthorized personnel, its warranty will be void.
- Scratches or other damages may occur to the display surface if it is exposed to sharp objects, abrasives or heavy impacts. This must be avoided to increase the longevity of the screen.
- The internal eMMC flash storage has a limited number of write cycles. Therefore it is recommended that the amount of writing to flash is limited within software applications.<sup>1</sup>
- Always consider personal safety when installing and operating the product. For example, in vehicle installations, CrossControl does not recommend that the product is being actively operated by the driver when a risk of injury to people or damage to property is present.

### 4.5.1. Cleaning



To ensure proper and reliable functionality over time, pay attention to the following cleaning instructions and precautions:

- Wipe the device clean from dirt using a soft damp cloth, preferably of microfiber type. Larger amount of dry dust may be swept off using a soft brush before wiping clean.
- Avoid using alkaline, alcoholic or other potentially adverse chemicals for cleaning as doing so may damage the device. However, small amount isopropyl alcohol may be used for removing harsh stains.
- Avoid spraying or by other means applying larger amount of water or alcohol directly to the device. Instead, lightly dampen a cloth before using it for cleaning the device.
- After cleaning, make sure that the device surface is left dry.
- Never use high-pressure air, vacuum, water or steam to clean the device.

### 4.5.2. Real time clock battery



Time and date information is stored in a memory sustained by an internal back-up battery. The battery is a 3V 1000mAh high operating temperature Poly-carbonmonofluoride Lithium battery. The expected life time of the battery is approximately 20 years. The battery is not replaceable.

---

<sup>1</sup> The eMMC is used in pseudo SLC mode and implements both static and dynamic wear levelling to reach the best reliability. The number of program/erase cycles is between 20k to 60k depending on the manufacturer and temperature. Our recommendation for the application software is to temporary cache in RAM and to write larger chunks of data to the eMMC. This recommendation is not specific to eMMC but is applicable to all flash memories.

## **4.6. Transportation**

When transporting the device it is recommended to use the original packaging. Make sure that protective caps are used on all non-mated connectors. The storage temperature interval [-40°C to +80°C] must be met.

## 5. Basic operation

This section covers basic operation of the product such as start-up, shut-down, suspend, resume, display operation and status notification.



Observe that the behaviour of the external on/off control is user configurable in terms of:

- Enabling/disabling functionality
- Configurable timing parameters
- Edge or level triggered

Notifications during start-up are indicated by the status LED or beeping with the buzzer in different patterns. The buzzer is used for audible alerts as well as for various error notifications, see chapter 5.6 for error code details.

The status notification behaviour in the operational state of the device is configurable by user applications. Described herein are the factory default behaviours of the on/off controls and the status notification.

### 5.1. Turning ON

The CCpilot V700 product can be started in different ways:

1. Connecting the external on/off control signal to a positive supply input (at or above approximately 6V).
  - When started this way, the on/off signal must remain asserted. De-assertion of this signal will shut down the device unless configured otherwise.
2. It is possible to configure the device to automatically start up whenever external power is applied (i.e. without using any on/off control).
  - a. Note that this function is disabled as factory default.

For resuming the device from suspend mode, see chapter 5.2.

While starting up the device, it will give a short beep and the status LED will flash with 2 Hz. When the device enters operational state the status LED will stop flashing and be turned on.

### 5.2. Turning OFF and suspending

There are several ways to turn off the CCpilot V700 device and also alternatives to enter suspend mode instead of completely shutting down the device.

#### 5.2.1. Shutting Down

There are a two ways to shut down the device, provided that it is in normal operational state when the action occurs:

1. By disconnecting the external on/off control for more than a specified time, i.e. using the turn-key functionality.
  - The time-out is user configurable and defaults to 4 seconds.

- If the on/off signal is brought back high again while the device is shutting down, it won't restart automatically. A low-to-high transition must occur after the device has fully shut down to make a restart.
2. By operating system shutdown requests.



To ensure that data is not lost nor the flash memory corrupted, it is recommended that all necessary data be saved and all programs closed before the device is shut down.

**Note** that the device won't shut down from Suspend mode by these actions. See chapter 5.2.2 for details of Suspend mode and wakeup.

When performing any of the above, the CCpilot V700 device will shut down.

### 5.2.2. Suspending/resuming

Suspending and resuming are faster alternative to shutting down and starting up the device. In suspend mode, the data remains in RAM memory and the device must be connected to external power supply to maintain its state.

Suspend mode can be entered in two ways:

1. By disconnecting the external on/off control, i.e. using the turn key functionality.
  - By factory default, disconnecting the external on/off control is configured to shut-down the device.
2. By selecting the operating systems suspend alternative.



Observe that the product current consumption in suspend mode is higher than in shut-down mode.

To prevent a vehicles or machines battery from draining when the device is suspended, a user configurable time-out can be set for how long the unit shall stay in suspend mode before it automatically shuts down. The default suspend time-out is set to 60 minutes.

Resuming from suspend mode can be done by the following event:

1. By a low-to-high transition of the external on/off control, i.e. using the turn-key functionality.

Configuration of suspend and resume is done through the CCSettingsConsole application or using the CCAux API. See the software guide for details.

## 5.3. Light sensor

The CCpilot V700 contains a light sensor that can be used to automatically adjust the display brightness, depending on the ambient light conditions. As depicted in Figure 2, the light sensor is located in the lower right corner of the front surface. When automated dimming is enabled, the level of sensitivity can be adjusted.



The screen brightness can also be manually controlled directly from user applications through APIs.

For proper operation it is important to keep the light sensor opening clean and with free visibility.

## 5.4. Using the touch screen

To reduce the amount of reflections when operating under sunny conditions, the touch screen's protective glass is covered with an anti-glare film. Do not use any sharp or abrasive objects when interacting with the touch screen.

Basic usage of the capacitive touch screen should be intuitive for most users. Note that the touch screen is capable of handling two simultaneous touches.

## 5.5. Status notification

The CCpilot V700 contains a status LED in the front used for notification while starting up, shutting down or in other operational states. The buzzer may also be used for user notifications. See Table 1 for a description of the status notification behavior for different operational states.

Table 1: LED and buzzer indication for different operational states

| Operational state                | LED indication          | Buzzer notification |
|----------------------------------|-------------------------|---------------------|
| Device off                       | OFF                     | -                   |
| Power applied, device off        | OFF                     | -                   |
| Starting up                      | Yellow flashing, 2 Hz   | Short beep          |
| Operating (started up)           | Static green            | -                   |
| Suspended                        | Yellow flashing, 0.2 Hz | -                   |
| Shutting down                    | Static green            | -                   |
| Rescue mode, starting            | Static orange           | Short beep          |
| Rescue mode, running             | Green flashing, 2 Hz    | -                   |
| Serial download mode (OS update) | Yellow flashing, 0.5 Hz | -                   |
| Forced update mode (OS update)   | Orange flashing, 0.5 Hz | -                   |
| SS firmware update mode          | Static yellow           | -                   |



Observe that the status notification behaviour in both the start-up and operating states is configurable by user applications running on the device.

## 5.6. Error codes

The status LED in the front is also used for indicating error codes by emitting a blue blinking pattern after shutdown of the device. The device may be started again when in this mode, by the key switch signal. Depending on the nature of the error, the device may start or go back into error indication.

When an error occurs, the device is immediately shut down and the error is reported by blinking a specific number of times corresponding to an error code (see table of error codes). The blinks will be in a continuous sequence of 1 Hz blinks, with a longer pause of two seconds after the specific number of blinks, allowing the end user to count the number of blinks. Refer to Figure 1 below for an example.



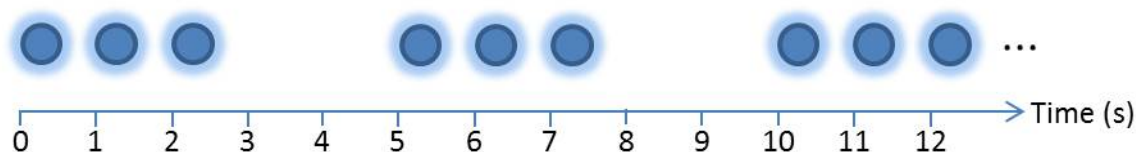

Figure 8: Example of the blinking pattern for error code 3

When an error occurs, an error code is also immediately saved to persistent storage (FRAM). If several errors occur before the device is shut down, only the code of the first error is saved and reported. The error code in persistent storage can be read and cleared from a user application.

Refer to Table 2: CCpilot V700 error codes for a complete listing of the error codes.

The number of blinks is important information if the unit is sent in for service/repair.

Table 2: CCpilot V700 error codes

| Error code | Error code name              | Likely problem cause   |
|------------|------------------------------|--|
| 1          | errCodeReadErrEEPROM         | Corrupted FRAM. Invalid values. FRAM may need to be manually reprogrammed or replaced.               |
| 2          | errCodeWriteErrEEPROM        | Corrupted FRAM. Invalid values. FRAM may need to be manually reprogrammed or replaced.               |
| 3          | errCodeDriverInit            | Failed to initialize one or several low level drivers.   |
| 4          | -                            | -  |
| 5          | errCodeMPDoneTimeoutErr      | Timeout waiting for the MP_DONE signal – MP error. Boot loader missing. Faulty or unprogrammed eMMC. |
| 6          | -                            | -  |
| 7          | errCodeTEMPOutOfLimits       | Temperature sensor malfunction or extreme operating conditions.                                      |
| 8          | -                            | -  |
| 9          | -                            | -  |
| 10         | errCodeRCCLInit              | SS circuit malfunction (clocks).   |
| 11         | errCodeSSState               | Programming bug or faulty processor.   |
| 12         | errCodeManageDiagnostics     | Failed to save diagnostic data to FRAM.  |
| 13         | errCodeManageActDeAct        | HAL_IO errors (SS internal).   |
| 14         | errCodeTickTimeOutTimer      | HAL_IO errors (SS internal).   |
| 15         | errCodeOperateModeStateError | SS internal.   |
| 16         | errCodeHALIOReadErr          | HAL_IO errors (SS internal).   |
| 17         | errCodeHALIOWriteErr         | HAL_IO errors (SS internal).   |
| 18         | -                            | -  |
| 19         | -                            | -  |
| 20         | -                            | -  |
| 21         | errCodeVMAINOutOfLimits      | External supply voltage out of limits.   |
| 22         | -                            | -  |
| 23         | -                            | -  |
| 24         | errCodeVREFOutOfLimits       | Internal reference voltage out of limits.  |
| 25         | -                            | -  |
| 26         | errCode5VOutOfLimits         | Internal 5V voltage out of limits.   |

## 6. Interface overview

This section describes the various interfaces of the product. Main part of these interfaces can be accessed via software APIs. These are described in the CCpilot V700 Software Guide.

### 6.1. Front panel

#### 6.1.1. Touch screen

The front panel contains a projective capacitive (PCAP) touch screen, which is capable of handling two simultaneous touches.

#### 6.1.2. Light sensor

There is a light sensor in the front panel used by user applications or used with the built-in automated function for dimming of the display brightness.

For light sensor location, see Figure 2. Refer to the CCpilot V700 Software guide for details about accessing the light sensor data from user applications.

#### 6.1.3. RGB status LED

The *CCpilot V700* contains a status LED in the front used for notification while starting up, shutting down or in other operational states.

### 6.2. Buzzer

The CCpilot V700 has a built-in buzzer that can be used for audible notifications. The buzzer is software controllable with configurable volume and frequency.

For buzzer location see Figure 3. See chapter 5.5 for buzzer notification events. Refer to the CCpilot V700 Software guide for details about controlling the buzzer from user applications.

### 6.3. CAN

The CCpilot V700 has two CAN ports that meets CAN ISO 11898 2.0B (29-bit extended identifier) and supports bit rates up to 1 Mbps.



Note that Internal EMI filters on CAN High/Low signals have a capacitance of 100 pF (typ) which deviates from the ISO 11898 standard and implies some limitations on the CAN bus topology (maximum bus length, number of CAN nodes etc.) when running at high bit-rates, i.e. above 250 kbps.

The ports feature highly protected CAN transceivers which are tolerant for bus short-circuits to main supply voltage and ground.

CAN shield connections are according to J1939-11 with capacitive coupling to ground. There is no device-internal CAN bus termination, therefore bus termination must be applied externally.

### 6.4. Ethernet

CCpilot V700 has one Ethernet interface supporting 10BASE-T/100-BASE-TX/FX and Auto-MDIX.

The Ethernet interface is galvanic isolated with 1.0 kV<sub>AC</sub> insulation voltage.

Shielded cables shall be used to ensure reliable communication and electromagnetic compliance.



As with all Ethernet enabled devices, connecting the device to a public network environment may impose an IT security threat.

### 6.5. USB

The CCpilot V700 has one (1) USB port. This port supports an USB OTG interface, i.e. acting as both host and device. Using the port in USB device mode is only for OS updates through a connected PC with appropriate tool installed.

In USB host mode, it can be used for application data transfer or the connection of a peripheral such as a mouse or keyboard.



Due to the M12 connector specification, USB data signal integrity cannot be guaranteed with higher speeds than full-speed USB (12 Mbps). However, hi-speed operation is supported by the USB host controller.

The USB port can supply up to 500 mA. The USB port is internally over current and short circuit to ground protected. Shielded cable shall be used to ensure reliable communication and electromagnetic compliance.

### 6.6. Bluetooth



The CCpilot V700 models with P/N C000152-01 have a Bluetooth module to facilitate wireless communication to and from the device. The Linux based operating system in the CCpilot V700 includes a software Bluetooth stack for easy application development including Bluetooth functionality.

Refer to the CCpilot V700 Programmers manual guide for details about implementing Bluetooth functionality in user applications.

Bluetooth chip and communication specification:

| Items                  | Specification  |
|------------------------|--|
| Radio certificates     | FCC/IC/CE/RCM/Giteki   |
| Antenna Type           | Internal   |
| Wireless specification | 802.11 b/g   |
| Bluetooth version      | V5.0 Dual Mode – BR / EDR / LE   |
| Frequency range        | 2.402 – 2.480 GHz  |
| Temperature range      | The Bluetooth module is operational in the CCpilot V700's full temperature range |
| Range                  | Circa 100 meters   |
| Max Transmit Power     | Class 1 +8dBm from antenna   |

## 7. Connectors

There are three M12 connectors, marked with 1, 2 and 3 accessible from the side of the device. Refer to 9 for an overview of the connectors.

### 7.1. M12 connectors, general

Pay close attention to the coding; violence or excessive force should not be used when mating the connectors.

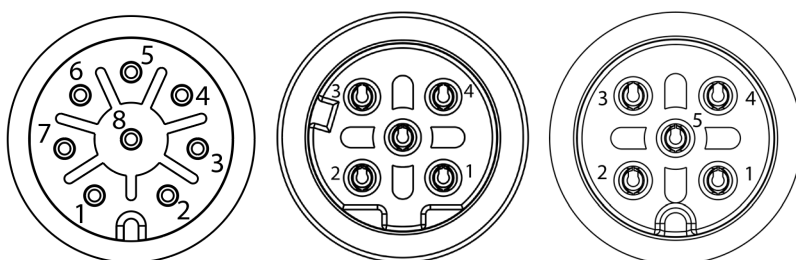

Figure 5: M12 connector pinout, 8-pin A-coded, 4-pin D-coded and 5-pin A-coded.



The M12 connector pins/receptacles are made of gold-plated copper-zinc alloy. It is recommended to use gold-plated pins/receptacles in the mating connectors. Using different plating in the cable connectors might cause galvanic corrosion. The M12 contact body is made of polyamide and the sleeve around it is made of nickel-plated zinc.



Note that all three M12 connectors must be mated with its corresponding cable connector or a proper blind plug to maintain the IP-classification.

### 7.2. Power and CAN M12 pinout

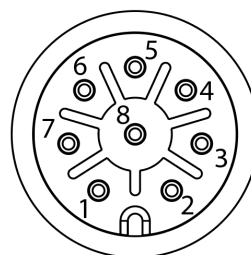

| Ethernet M12 Connector                            |  |
|---|--|
| Matching plug: Female, 8-pin, A-coded with shield |  |
| Pin   | Signal   |
| 1   | Power supply   |
| 2   | Ground   |
| 3   | *Force pin for USB serial download mode of the i.MX 8X |
| 4   | Key switch signal                                      |
| 5   | CAN1 high  |
| 6   | CAN1 low   |
| 7   | CAN2 high  |
| 8   | CAN2 low   |

Table 3: Power and CAN M12 connector pinout

\*Pin for forcing the USB serial download mode of the i.MX 8X for flashing of boot and/or image. Active high. Leave floating or grounded for normal operation.

### 7.3. Ethernet M12 pinout

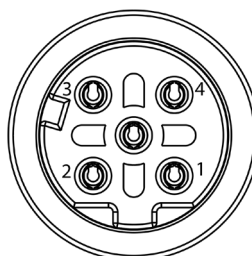

| Ethernet M12 Connector                          |        |
|---|--------|
| Matching plug: Male, 4-pin, D-coded with shield |        |
| Pin   | Signal |
| 1   | TX+    |
| 2   | RX+    |
| 3   | TX-    |
| 4   | RX-    |
| Housing   | Shield |

Table 10: Ethernet M12 connector pinout

### 7.4. USB M12 connector pinout

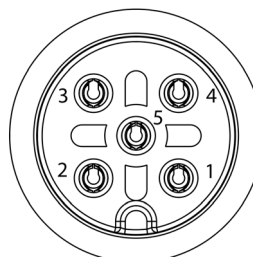

| USB M12 Connector                               |                   |
|---|-------------------|
| Matching plug: Male, 5-pin, A-coded with shield |                   |
| Pin   | Signal            |
| 1   | VBUS              |
| 2   | Data-             |
| 3   | Data+             |
| 4   | Ground for shield |
| 5   | Ground            |

Table 11: USB M12 connector pinout

## 8. Specifications

### 8.1. Technical data

| Temperature specification |               |
|---------------------------|---------------|
| Operating                 | -30 to +70 °C |
| Storage                   | -40 to +80 °C |

| Kernel         |  |
|----------------|--|
| Main Processor | NXP™ i.MX8 DualXPlus: ARM 64-bit, 1200MHz, Cortex®-A35 |
| Co-processor   | STMicroelectronics STM32F071VB, Cortex®-M0             |
| Data storage   | 4 Gbyte, Industrial grade eMMC <sup>(Note)</sup>       |
| RAM memory     | 1 Gbyte, LPDDR4  |



Note: The eMMC is used in pseudo SLC mode and implements both static and dynamic wear levelling to reach the best reliability. The number of program/erase cycles is between 20k to 60k depending on the manufactures and temperature. Our recommendation for the application software is to temporary cache in RAM and to write larger chunks of data to the eMMC. This recommendation is not specific to eMMC but is applicable to all flash memories.

| Power Supply   |  |
|----------------|--|
| Supply voltage |  |
| Nominal        | 12 V <sub>DC</sub> or 24 V <sub>DC</sub> |
| Extreme        | 6 V <sub>DC</sub> ...36 V <sub>DC</sub>  |

| Power consumption  |                                      |                                      |
|--------------------|--------------------------------------|--------------------------------------|
|                    | V <sub>in</sub> = 12 V <sub>DC</sub> | V <sub>in</sub> = 24 V <sub>DC</sub> |
| Typical, operating | 580 mA (typ)                         | 290 mA (typ)                         |
| Max, operating     | 750 mA                               | 390 mA                               |
| Suspend to RAM     | 37 mA (typ)                          | 22 mA (typ)                          |
| Shutdown           | 123 µA (typ)*                        | 0.38 mA (typ)*                       |

\* This assumes that the ignition signal is disconnected from supply voltage.

| Inrush current   |                                      |                                      |
|------------------|--------------------------------------|--------------------------------------|
|                  | V <sub>in</sub> = 12 V <sub>DC</sub> | V <sub>in</sub> = 24 V <sub>DC</sub> |
| Duration ca 2 ms | < 2.0 A                              | < 1.5 A                              |

| External fuse recommendation |        |                                    |
|------------------------------|--------|------------------------------------|
| Current rating               | 2-3 A* | (including maximum external loads) |

\* This assumes that the fuse is in accordance with IEC 20127 i.e. can be continuously operated at 100% of rated current.

| CAN interfaces  |   |
|-----------------|---|
| Type            | Non-isolated, ISO 11898-1, CAN 2.0B with cable shield decoupling according to J1939-11.<br>Supports ISOBUS  |
| CAN transceiver | NXP TJA1051T/3  |
| Baud Rate       | 20 – 250 kbps (up to 1 Mbps)*<br>* Internal CAN bus filters have a capacitance of 100pF (typ) as stated in the J1939 specification. This puts restrictions on the CAN bus topology considering bus length, number of CAN nodes etc. when running at bit-rates higher than 250 kbps. |
| Protection      | Short circuit protected to -36V to +36V   |

| USB interfaces |   |
|----------------|---|
| Type           | 1x USB 2.0 compatible host ports  |
| Speed          | Full-speed (12 Mbps) and Hi-speed USB (480 Mbps) is supported.  |
| VBUS supply    | 5.0 V, 0.5 A per port, internally over-current (typically 0.7 A) and short-circuit to ground protected. |

| Ethernet           |  |
|--------------------|--|
| Type               | 10/100 Mbps Ethernet compatible with 10BASE-T and 100BASE-TX Ethernet standards.<br>Auto-MDIX support. |
| Insulation voltage | 1500V <sub>AC</sub> .  |

| Buzzer             |   |
|--------------------|---|
| Frequency range    | 700 – 10 kHz (SPL peak at 2830 Hz)  |
| SPL range          | <32 dBA (min) 79 dBA (max) at 0.1 meter (typ, 2830 Hz)  |
| with VESA mount    | <32 dBA (min) 78 dBA (max) at 0.1 meter (typ, 2830 Hz)  |
| without VESA mount | The buzzer is located on the back (connector side) of the device and the effective SPL varies dependent on the acoustic properties of the installation environment. |

| Software            |  |
|---------------------|--|
| Operating system    | CCLinux  |
| Additional software | CCAux API, CCSettingsConsole. Refer to the <i>CCpilot V700 Software Guide</i> and <i>Programmer's guide</i> for details. |

| Display                    |   |
|----------------------------|---|
| Size                       |   |
| Diagonal size              | 7.0 inch widescreen   |
| Active area                | 152.4 x 91.44 mm  |
| Pixel pitch                | 0.1905 x 0.1905 mm  |
| Type                       | TFT a-Si (IPS)  |
| Aspect ratio               | 15:9  |
| Resolution                 | WVGA, 800x480   |
| Colour depth               | 24 bit (16.7M colors)   |
| Contrast ratio             | 800:1 (min), 1000:1 (typ)   |
| Viewing angle              | Horizontal: ± 88°<br>Vertical: ± 88°  |
| Backlight                  | LED   |
| Type                       | 800 cd/m <sup>2</sup> (typ)   |
| Brightness                 | 50 000 h (typ) before brightness is reduced with 50 % (when operated with full brightness at 25 °C) |
| LED Life time              | (Note that higher operating temperatures affects LED life time.)                                    |
| Cover glass                |   |
| Protective glass thickness | 1.8 mm  |

|                  |            |
|------------------|------------|
| Coating          | Anti-Glare |
| Surface Hardness | 6H         |

## 8.2. Environmental specifications

| Environmental Test           | Test standard       | Notes   |
|------------------------------|---------------------|---|
| Dry Heat                     | IEC 60068-2-2:2007  | Operating: +70°C, 24h<br>Storage: +80°C, 24h        |
| Damp Heat                    | IEC 60068-2-30:2005 | Operation: +25°C / +55°C<br>>95% RH 6*24h           |
| Cold                         | IEC 60068-2-1:2007  | Operating: -30°C, 24h<br>Storage: -40°C, 24h        |
| Change of temperature        | IEC 60068-2-14:2009 | -20°C to +70°C, 5°C/min<br>1hr hold time, 20 cycles |
| Vibration                    | IEC 60068-2-64:2008 | 0.02 g <sup>2</sup> /Hz 5-2000 Hz<br>3x3h           |
| Shock                        | IEC 60068-2-27:2008 | ± 25 g / 6ms ±3x2500 impulses                       |
| Enclosure Ingress Protection | IEC 60529:2014      | IP65, IP66 and IP67                                 |



Any changes or modifications to the device not expressly approved by CrossControl could void the environmental classification, warranty, and user's authority to operate the equipment.

## 8.3. EMC specification

The CCpilot V700 device has been tested for Electromagnetic Compatibility according to the following standards EN ISO 14982, EN ISO 13766-1 and EN ISO 13766-2.

| EMC Test                            | Test standard                  | Notes        |                  |                   |
|-------------------------------------|--------------------------------|--------------|------------------|-------------------|
| Electrical Transients               | ISO 7637-2:2011<br>12 V system | <b>Pulse</b> | <b>Level</b>     |                   |
|                                     |                                | 1            | -75V             |                   |
|                                     |                                | 2a           | +37V             |                   |
|                                     |                                | 2b           | +10V             |                   |
|                                     |                                | 3a           | -112V            |                   |
|                                     | 24 V system                    | 3b           | +75V             |                   |
|                                     |                                | 4            | -6V              |                   |
|                                     |                                | 5            | +65V, Ri = 2Ω    |                   |
|                                     |                                | 1            | -450V            |                   |
|                                     |                                | 2a           | +55V             |                   |
| ESD immunity                        | ISO 10605:2008                 | Air          | ± 15 kV          |                   |
|                                     |                                | Contact      | ± 8 kV           |                   |
| Radiated RF immunity <sup>(1)</sup> | ISO 11452-2:2019               | <b>MHz</b>   | <b>Level</b>     | <b>Modulation</b> |
|                                     |                                | 200-1000     | 100 V/m          | 80%AM, 1kHz       |
|                                     |                                | 1000-2000    | 30V/m            | PM                |
|                                     |                                | 2000-2400    | 10V/m            | PM                |
| Radiated RF emission <sup>(1)</sup> | ISO 11452-4:2011 (BCI)         | 2400-2700    | 5V/m             | PM                |
|                                     |                                | <b>MHz</b>   | <b>Level</b>     | <b>Modulation</b> |
| Radiated RF emission <sup>(1)</sup> | ISO 13766-1:2018               | 1-200        | 100 mA           | 80%AM, 1kHz       |
|                                     |                                | <b>MHz</b>   | <b>Narrow-b.</b> | <b>Broad-b.</b>   |
|                                     |                                | 30-75        | dBµV/m           | dBµV/m            |
|                                     |                                |              | 54-44            | 64-54             |



|  |          |       |       |
|--|----------|-------|-------|
|  | 75-400   | 44-55 | 54-65 |
|  | 400-1000 | 55    | 65    |

(1) Compliance to RF immunity and RF emission standards require use of shielded cables for Ethernet, USB and Video interfaces.

EMC tests are performed at 24 V<sub>DC</sub> supply voltage unless other levels are specified in test standards.

System level compliance to EMC standards may be affected by external factors like mounting, omitting the use of shielded cables etc.

### 8.4. Weight and dimensions

| Attribute          | Description  | Comments                  |
|--------------------|--|---------------------------|
| Dimensions         | 201 x 135 (140) x 40 mm                              | (W x H (H+connector) x D) |
| Weight             | 0.62kg   |                           |
| Mounting holes     | RAM-202U   |                           |
| Spacing            | Dia 46 mm  |                           |
| Thread dimension   | M5   |                           |
| Thread depth       | 8.0 mm   |                           |
| Enclosure material | PBT + PC plastic, impact modified and flame retarded |                           |

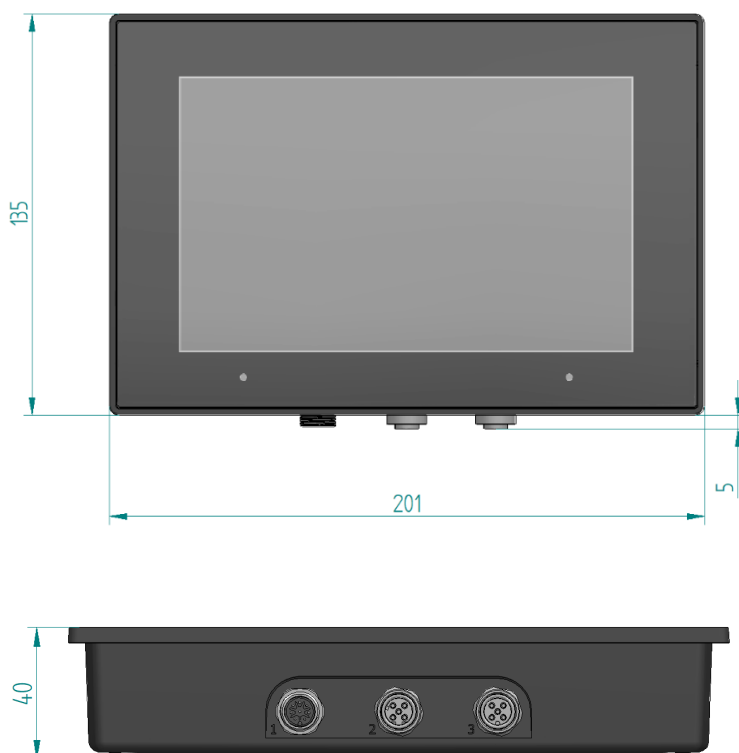

Figure 6: CCpilot V700 dimensions.

## Technical support

Additional sources of information are available on the CrossControl support site:

<http://support.crosscontrol.com>

Contact your reseller or supplier for help with possible problems with your device. In order to get the best help, you should have your device in front of you and be prepared with the following information before you contact support.

- Part number and serial number of the unit, which you find on the identification label, see Figure 1.
- Date of purchase, which is found on the invoice.
- The conditions and circumstances under which the problem arises.
- Error codes signaled by the internal buzzer.
- Possible error messages which are shown.
- Device log files (if possible).
- Information regarding possible external equipment which is connected to the device.

## Trademarks and terms of use

© 2020 CrossControl

All trademarks sighted in this document are the property of their respective owners.

- NXP™ is a trademark of NXP Semiconductors Inc.
- Arm® is a registered trademark of ARM Limited.
- Linux® is a registered trademark of Linus Torvalds in the U.S. and other countries.
- CrossControl and CCpilot are trademarks of CrossControl AB.

CrossControl is not responsible for editing errors, technical errors or for material which has been omitted in this document. CrossControl is not responsible for unintentional damage or for damage which occurs as a result of supplying, handling or using of this material including the devices and software referred to herein. The information in this handbook is supplied without any guarantees and can change without prior notification.

For CrossControl licensed software, CrossControl grants you a license under CrossControl intellectual property rights to use, reproduce, distribute, market and sell the software, only as a part of or integrated within, the devices for which this documentation concerns. Any other usage, such as, but not limited to, reproduction, distribution, marketing, sales and reverse engineer of this documentation, licensed software source code or any other affiliated material may not be performed without written consent of CrossControl.

CrossControl respects the intellectual property of others, and we ask our users to do the same. Where software based on CrossControl software or products is distributed, the software may only be distributed in accordance with the terms and conditions provided by the reproduced licensors.

For end-user license agreements (EULAs), copyright notices, conditions, and disclaimers, regarding certain third-party components used in the device, refer to the copyright notices documentation.